

## HK1814-RS

Drawn cup needle roller bearing open end

Schaeffler ID:  
0007010170968

Drawn cup needle roller bearings with open ends HK..-RS, lip seal on one side, to DIN 618

### Technical information

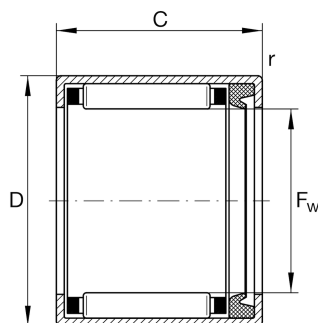

#### Main Dimensions & Performance Data

$F_w$	18 mm	Under roller diameter
$D$	24 mm	Outside diameter
$C$	14 mm	Width
$C_r$	8,100 N	Basic dynamic load rating, radial
$C_{0r}$	10,900 N	Basic static load rating, radial
$C_{ur}$	1,330 N	Fatigue load limit, radial
$n_G$	8,400 1/min	Limiting speed
$n_{G \text{ Grease}}$	8,400 1/min	Limiting speed for grease lubrication
	14.43 g	Weight

#### Dimensions

$C_1$	14 mm	Width, outer ring
$r_{\min}$	0.8 mm	Minimum chamfer dimension
	LR15X18X16,5	Suitable inner rings LR
	IR15X18X16-XL	Suitable inner rings IR

#### Temperature range

$T_{\min}$	-20 °C	Operating temperature min.
$T_{\max}$	100 °C	Operating temperature max.